

Standart

SDS

SDS DOUBLE SUCTION SPLIT CASE CENTRIFUGAL PUMPS

INSTRUCTION for INSTALLATION, OPERATION & MAINTENANCE

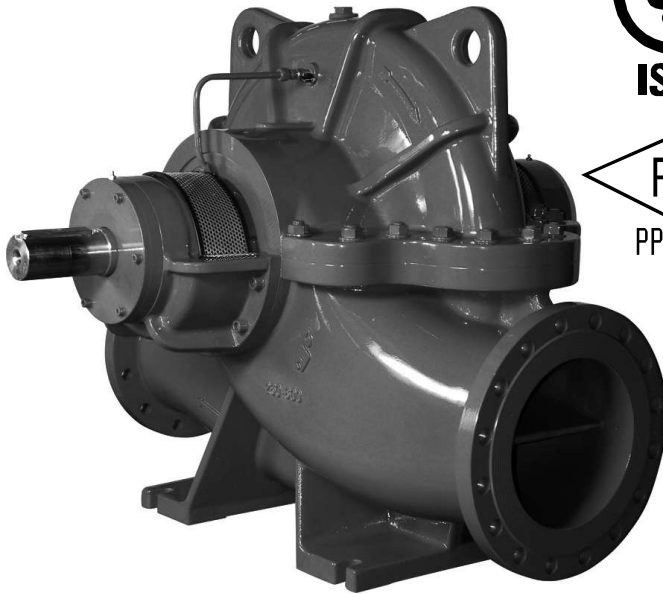

ISTED



PPROVED

| | |
|-------------|--------------------------|
| Pump Type | : |
| Serial No | : |
| Capacity | :m ³ /h |
| Head | :m |
| Motor Power | :kW |
| Speed | :rpm |



BK SDS 00 06-11 EN

Instructions for Installation, Operation and Maintenance

Standart Pompa ve Makina San. Tic. A.Ş.

All rights reserved. Can not be copied or reproduced for any purpose without permission.
Subject in the manual can be changed without any prior notice.

Contents

| | |
|---|------------|
| CONTENTS | i |
| IDENTIFICATION OF SAFETY AND WARNING SYMBOLS | iii |
| GENERAL INSTRUCTIONS | iii |
| SAFETY INSTRUCTIONS | iii |
| A- GENERAL | 1 |
| A1- Pump Description | 1 |
| A2- Applications | 1 |
| A3- Pump Designation | 1 |
| A4- Pump Nameplate | 1 |
| A5- Technical Data | 1 |
| B- UNCRATING, TRANSPORT AND STORAGE | 2 |
| B1- Uncrating | 2 |
| B2- Transport | 2 |
| B2.1- General recommendations | 2 |
| B2.2- Lifting | 2 |
| B3- Storage | 3 |
| C- INSTALLATION ON SITE | 3 |
| C1- Bare Shaft Pump | 3 |
| C2- Preparation For Installation | 3 |
| C3- Installation Site | 3 |
| C3.1- Foundation | 3 |
| C3.2- Installation | 3 |
| C4- Coupling Alignment | 4 |
| C5- Connection The Piping | 5 |
| C5.1- General | 5 |
| C5.2- Suction piping | 6 |
| C5.3- Discharge piping | 6 |
| C5.4- Auxiliary pipe connections and accessories | 6 |
| C5.5- Minimum flow | 7 |
| C5.6- Electrical connections | 7 |
| C5.7- Final check | 8 |
| D- START UP / SHUT DOWN | 8 |
| D1- Preparation | 8 |
| D1.1- Lubrication control | 8 |
| D1.2- Check the shaft seal | 8 |
| D1.3- Venting and priming | 8 |
| D1.4- Checking the direction of rotation | 9 |
| D2- Start Up The Pump | 9 |
| D3- Shut Down The Pump | 9 |
| D4- Checks To Be Made While The Pump Is Running | 9 |

| | | |
|-----------|---|-----------|
| E- | LUBRICATION | 10 |
| F- | DISASSEMBLY, REPAIR AND REASSEMBLY | 10 |
| | F1- Disassembly | 10 |
| | F2- Reassembly | 11 |
| | F3- Shaft Seal | 11 |
| G- | SPARE PARTS | 12 |
| H- | FAULTS, CAUSES AND REMEDIES | 12 |
| I- | TIGHTENING TORQUES | 14 |
| J- | EXPECTED NOISE VALUES | 14 |
| K- | PERMISSIBLE FORCES AND MOMENTS AT THE PUMP FLANGES | 15 |
| L- | SECTIONAL DRAWINGS | 16 |
| N- | COUPLING GUARD AND SAFETY GUARD | 17 |

This manual is intended to be a reference guide for users of pumps providing information on

- Pump installation and maintenance instructions,
- Pumps start-up, operation and shut - down procedures.

IDENTIFICATION OF SAFETY AND WARNING SYMBOLS



Safety instructions in this manual which could cause danger to life if not observed.



The presence of a dangerous electric current.



Non – observance to this warning could damage the machine or affect its functions.

GENERAL INSTRUCTIONS



- **This manual should be kept in a safe place and ALWAYS be available to the QUALIFIED operating and maintenance personnel responsible for the safe operation and maintenance of the pumps.**

- Qualified personnel should be experienced and knowledgeable of safety standards.
- To avoid faulty operation and malfunctioning of pumps the instructions in this manual are to be CAREFULLY studied and followed at all stages of the pump installation and operating life.
- The user is responsible for ensuring that inspection and installation are carried out by authorized and qualified personnel who have studied this manual carefully.
- The pump should be used ONLY in the operating conditions given on the order for which the pump and materials of the construction have been selected and tested.
- If the pump is to be used for a different application please contact sales office or representative of the manufacturer. STANDART POMPA refuses to assume any responsibility if the pump used for different applications without prior written permission.
- If the pump is not to be installed and operated soon after arrival, it should be stored in a clean and dry place with moderate changes in ambient temperature. Extreme low or high temperatures may severely damage the pump unless suitable precautions are taken. The user is responsible for the verification of the ambient conditions where the pump will be stored or installed.
- STANDART POMPA does not guarantee repairs or alterations done by user or other unauthorized personnel. The use of original spare parts and accessories authorized by manufacturer will ensure safety.
- This manual does not take into account any site safety regulation, which may apply.

SAFETY INSTRUCTIONS



Strictly obey to the following instructions to prevent personal injuries and/or equipment damages:

- Pump should be used only in the specified operating conditions.
- Any weight, stress or strains on the piping system should not be transmitted to the pump.
- Electrical connections on the motor or accessories must always be carried out by authorized personnel and in accordance to the local codes.
- Any work on the pump should be only carried out when the unit has been brought to standstill.
- **Always disconnect the power to the motor and make sure not be switched on accidentally before working on the pump or removing the pump from installation.**
- Any work on the pump should be carried out by at least two persons.
- When approaching the pump always be properly dressed and/or wear safety equipment suitable for the work to be done.
- Do not work on the pump when it is hot.
- Do not touch the pump or piping with temperatures higher than 80 °C. User must take suitable precaution to warn the persons (e.g. using warning signs, barrier).
- Always be careful when working on pumps that handling dangerous liquids (e.g. acids or hazardous fluids).
- Do not work on the pump when the pump and piping connected to the pump are under pressure.
- After completion of the work always fix the safety guards back in places previously removed.
- Do not run the pump in the wrong direction of rotation.
- Do not insert hands or fingers into the pump openings or holes.
- Do not step on the pump and/or piping connected to the pump.

S8G PUMPS

A- GENERAL

A1- Pump Description

- SÖÜ series pumps are horizontal, split volute casing, single stage, end suction centrifugal pumps with closed impeller.
- SÖÜ series pumps are fire pumps which is designed in accordance with UL 448 and FM Class 131F standards.



A2- Applications

SÖÜ series pumps are suitable for clean or slightly contaminated (max. 20 mg/dm³) liquids with low viscosities.

A3- Pump Designation

Pump type _____ S8 G %0 - 250
Discharge nozzle (DN - mm) _____
Nominal impeller diameter (mm) _____

A4- Pump Nameplate

| | | | |
|---|---|---|------------------|
|  Pompa ve Makina San. Tic. A.Ş. Ümraniye / İstanbul / Turkey +90 216 466 89 00 | |  | |
| Centrifugal Fire Pump | |  | |
| Split Case | | | |
| <u>Type</u> | | <u>Serial NO</u> | |
| SDS ... - ... | | | |
| <u>Q (rated)</u> | @ | <u>H (rated)</u> | <u>n (rated)</u> |
| ... GPM | | ... PSI | ... RPM |
| <u>D</u> | | <u>No of Stages</u> | |
| ... mm | | . | |
| Max. Net Pressure Developed | : | | PSI |
| Net Pressure at %150 Capacity | : | | PSI |
| Max. BHP | : | | HP |
| Max. Positive Suction Pressure | : | | PSI |

A5- Technical Data

Speed : up to 3000 rpm
Suction and discharge Flanges : ANSI B16.1 Class 250
Ambient Temperature (max) : 40 °C

B- UNCRATING, TRANSPORT AND STORAGE

B1- Uncrating

- Upon receipt verify that the goods received are in exact compliance with that listed on the packing list.
- Check that no visible damage exists on the crate that could have occurred during transportation.
- Carefully remove the packaging material and check that pump and accessories (if any) are free from any markings, stretches and damages, which may have occurred during transportation.
- In the event of damage report this immediately to STANDART POMPA's service department and to the transport company.

B2- Transport

B2.1- General recommendations



- Existing regulations for the prevention of accidents must be followed.
- Wearing of gloves, hard-toed boots and hard hats is obligatory for all transport works.
- Wooden cases, crates, pallets or boxes may be unloaded with fork-lift trucks or using hoisting slings, depending on their size, weight and construction.

B2.2- Lifting

- Prior to lifting and moving the pump or pump and motor on a common base plate find out the following:
 - Total weight and center of gravity
 - Maximum outside dimensions
 - Lifting points location
- The load-bearing capacity must be proper to the weight of the pump or the pump set.
- The pump or pump set must always be raised and transported in horizontal position.
- It is absolutely forbidden to stand beneath or nearby a raised load.
- A load should never remain in a raised position for longer than necessary.
- Accelerating and braking during the lifting process must be performed such that there is no danger to persons.

When lifting the pump or complete pump set lift them as shown in **Fig. 1a** and **Fig. 1b** respectively to avoid any distortion (especially do not use the motor eyebolt for carrying the complete unit).

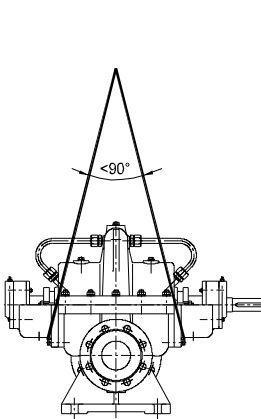

Fig. 1a. Bare shaft pump

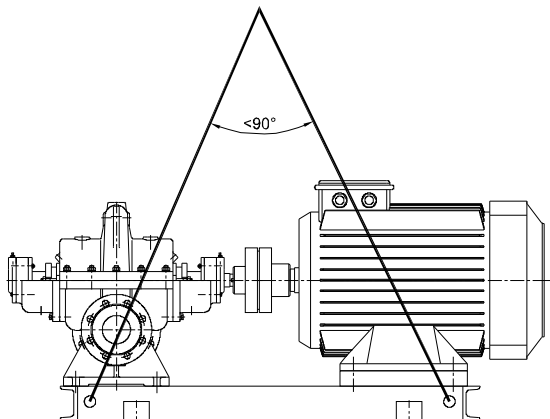

Fig. 1b. Pump and motor on a common baseplate

B3- Storage

- If the pump is not to be installed and operated soon after arrival, store the pump in a clean, dry and frost-free place with moderate changes in ambient temperature.
- If the pump has regreaseable bearings, pump extra grease on bearings to prevent moisture from entering around the shaft.
- To prevent the pump from moisture, dust, dirt and foreign materials suitable steps should be taken.
- The pump shaft should be revolved periodically (e.g. once a week) to prevent pitting of the bearing surfaces and the pump from seizing up.

C- INSTALLATION ON SITE

ATTENTION Installation has to be carried out in accordance with EN 60204-1.

The pump should only be installed, levelled up and aligned by skilled personnel. Incorrect installation or defective foundation could result in troubles. This would not be covered by the warranty.

C1- Bare Shaft Pump

- If the pump has been supplied with bare shaft end it is required to prepare a proper base plate on which to mount the pump and motor assembly. The base plate must be properly designed and manufactured for enough rigidity to prevent vibrations and distortions.
- If the pump has been supplied without electric motor and coupling it is necessary to select a proper motor and coupling before proceeding to the installation of the unit.

The following considerations must be taken into account for selection of motor:

- Maximum power absorbed by the pump over the total operating range,
- Pump operating speed,
- Available power (frequency, voltage, etc.)
- Motor type (TEFC, exproof, etc.)
- Motor mounting position (foot mounted, flange mounted, horizontal, vertical, etc.)

When selecting coupling nominal motor power and operating speed must be taken into account.

C2- Preparation For Installation

Before installing the pump

- Clean the suction and discharge flanges thoroughly.
- Remove the protective coating from the pump shaft.
- If the pump has been in temporary storage remove all the grease from the bearings with grease lubricated or remove the oil from the bearing house if the pump is oil-lubricated, then clean the bearings with a suitable cleaning fluid and relubricate (NOTE: This is not necessary for the pumps with life time grease lubricated bearings).

C3- Installation Site

ATTENTION • The pump must be installed in a frost and dust-free, well-ventilated and non-explosive environment.

- The pump should be installed such that there is space for access, ventilation, maintenance and there is sufficient space above the pump for it to be lifted.
- The suction pipe should be kept as short as possible.

C3.1- Foundation

ATTENTION • The greatest care must be taken in preparing the foundation and mounting the pump set. Incorrect installation will result in premature wear of pump components and break down of the pump.

- The foundation should be heavy enough to reduce vibrations and rigid enough to avoid any twisting or misalignment. Make sure the concrete foundation has set firm and solid before mounting the pumpset. The surface of the foundation should be truly horizontal and perfectly flat.

C3.2- Installation

- Place the pumpset on the concrete and by adding or removing shims under the baseplate align the discharge flange horizontally by using a spirit level on it as shown on **Fig.2** Make sure it is completely horizontal.

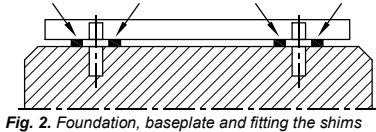

Fig. 2. Foundation, baseplate and fitting the shims

- Slightly tighten the anchor bolts.
- Check the coupling alignment as explained in section C4.
- Fill in the baseplate with concrete. Make no air left in it and the baseplate is well integrated with concrete foundation.
- Wait until the concrete firmly set (minimum 3 days).
- Tighten the anchor bolts. CHECK THE COUPLING ALIGNMENT AGAIN

C4- Coupling Alignment

ATTENTION • For a trouble free service life of the pumping unit the most important factor is aligning the coupling property. The main reason for vibration, noisy operation, warming bearings and overloading is an unaligned or misaligned coupling. Therefore the coupling should be correctly aligned and be checked frequently.

• A flexible coupling should never be expected to correct misalignment. A FLEXIBLE COUPLING IS NOT A CURE FOR MISALIGNMENT AT ALL AND IT DOES NOT COMPENSATE FOR EXCESSIVE MISALIGNMENT. A flexible coupling will only compensate for small amount of misalignment.

ATTENTION • “Coupling Alignment” means to secure the motor and pump rotation axes on the same straight line. SKM series pumps are dispatched from our factory after the coupling alignment is precisely secured if supplied with driver and baseplate. A certain amount of deformation of the baseplate is possible during handling and transit. For this reason, regardless of the excellent alignment made at factory, THE PUMP AND DRIVER HAVE TO BE REALIGNED DURING INSTALLATION.

• A 100 mm long metal stripe with straight edge (steel ruler) and a precise calliper are needed to align the coupling (special instruments must be used for a very fine and precise alignment).

• There may be two forms of errors for coupling alignment:

- Angular error,
- Parallel sliding error,

• To check the angular error, the gap between the coupling halves must be the same at all points horizontally and vertically.

• To control parallel sliding error, straight edged steel ruler is pressed down on one half of the coupling in parallel to the axis. It is checked against the other half. Straight edge must touch to the both half couplings completely same at all points in each vertical and horizontal planes (Fig. 3).

• Alignment errors can be either on vertical plane or horizontal plane. On vertical plane alignment is corrected by inserting shims under the pump or motor foot, and on horizontal plane alignment is corrected by sliding the pump and/or motor horizontally sideways by using the gaps at mounting holes. Fig. 4a, 4b, 4c, 4d show alignment of coupling step by step.

ATTENTION Following any alternation, each alignment should be rechecked because any movement due to an adjustment in one direction may cause misalignment in another.

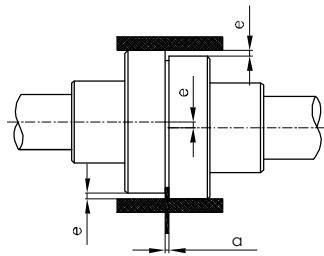

Fig. 3. Aligning a flexible coupling

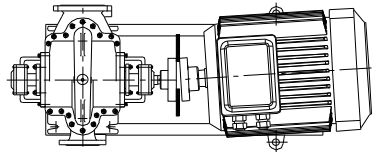

Fig. 4a. Angle error in horizontal plane and to settle

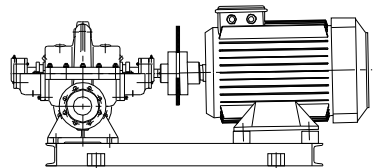

Fig. 4b. Angle error in vertical plane and to settle

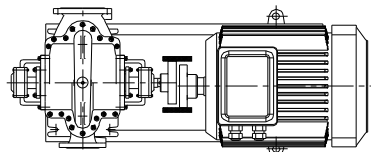

Fig. 4c. Parallel sliding error in horizontal plane and to settle

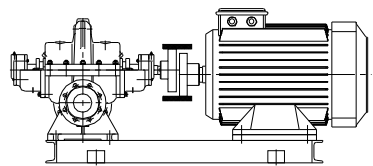

Fig. 4d. Parallel sliding error in vertical plane and to settle

C5- Connecting The Piping

C5.1- General

ATTENTION • Never use the pump as an anchorage point or as a carrier for the piping.

- The pipes should be supported very near the pump (**Fig. 5**). It must be checked that any weight, stress or strains on the piping system should not be transmitted to the pump. Therefore after completing the piping installation, the bolt and connection on the suction and discharge nozzles must be loosened to ensure that there is not any stress on the piping system to the pump.
- **The nominal sizes of the pump suction and discharge nozzles are no guide to the correct sizes of the suction and discharge piping.** The nominal bores of the pipes should be same as or greater than those of the pump nozzles. Never use pipes or accessories which have smaller bore than the pump nozzles. Particularly foot valves, strainers, filters and non return valves must be preferred with larger free transition areas. In general the flow velocities should not exceed 2 m/s in the suction piping and 3 m/s in the discharge piping. Higher flow velocities will result in higher pressure drops, which could cause cavitation conditions in the suction piping and excessive friction losses in the discharge piping.
- Pipe joints should be by means of flanges with flange gaskets of proper size and material. Flange gasket must be centered between the flange bolts in a such way that there is no interference with the flow of the liquid.
- Thermal expansions of the pipework and excessive vibrations should be accommodated by suitable means so as not to impose any extra load on the pump.
- Prevent impurities such as welding beads, scale, sand and tow might be left in pipes while production of the piping system harms the pump. Seal the pump nozzles by means of blind gasket to stop impurities get in the pump. After assembling the system all the piping parts must be disassembled, thoroughly cleaned, painted and reassembled again. If a strainer is used on the suction side of the pump, it must be cleaned after several days of operation.

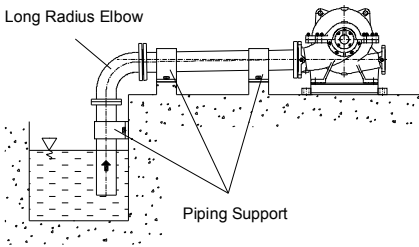

Fig. 5a. Suction Lift

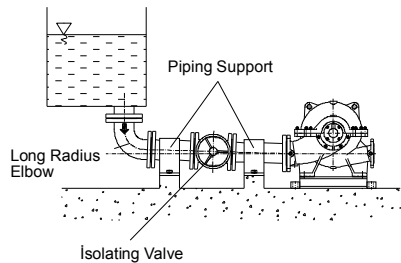

Fig. 5b. Suction Head

C5.2- Suction piping (Fig. 5, 6)

- The suction piping must be absolutely leak-tight and not present any features likely to promote the formation of air pockets. Suction piping therefore should have a slight downward slope towards the pump in the case of suction head installation (e.g. flooded suction) and slight upward slope towards the pump in the case of suction lift installation.
- In order to keep the pipe friction losses as low as possible it is essential to avoid any sharp bends and abrupt changes of direction or cross-section and the suction pipe should be kept as short as possible. If it is necessary to change the cross-section of a piping laid almost horizontal, an eccentric reducer, with top horizontal, should be used.
- A positive suction head piping should incorporate an isolating valve with the valve stem in the horizontal position. This valve should always remain fully open while the pump is running and must not be used to regulate the flow.

C5.3- Discharge piping (Fig. 6)

- A control valve should be installed in the discharge pipe, as close to the pump as possible, to regulate the required flow and head.
- If the total head of the pump exceeds 10 meters or if discharge line is of appreciable length a non return valve should be installed between the pump and isolating valve on the discharge line to protect the pump against water hammer and reverse flow on shut down.

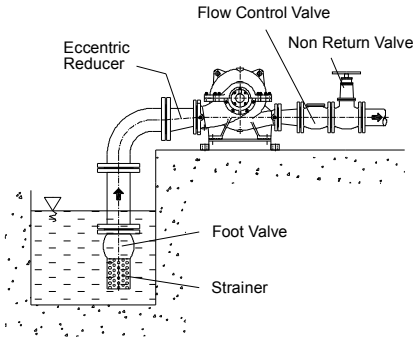

Fig. 6a. Suction Lift

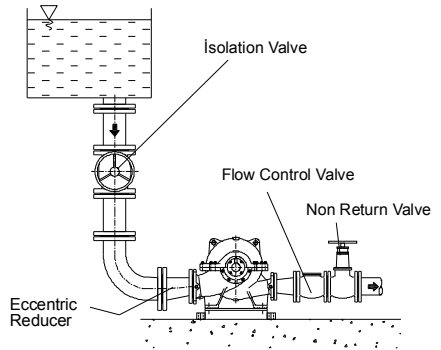

Fig. 6b. Suction Head

C5.4- Auxiliary pipe connections and accessories

- Depending on the application auxiliary pipe connections (for cooling, sealing and flushing of seal, drainage etc. necessary for the pumping system) and/or accessories to check the operating conditions (pressure gages, temperature gages etc.) may be made up and laid.
- Pressure and vacuum gauges must be properly anchored and connected at the measuring points located on the pump flanges by means of or on the pipes close to the flanges approximately 8 mm diameter tubing with pig tail configuration to lessen pressure fluctuation. For safety purposes isolating and vent valves should be fitted before the gages (**Fig. 7**).
- Every pump is fitted with connections on the pump casing to drain the pump and on the bearing bracket to evacuate the seal leakage from the stuffing box (**Fig. 8**). If required the pump drain and seal leakage can be piped to a suitable reservoir. The pump draining piping must be fitted with an isolating valve and both must be suitable for the maximum operating pressure of the pump.
- Cooling, sealing and flushing of seal piping must be connected only to the designated connections located on the pump (**See Fig. 8 to 12**).

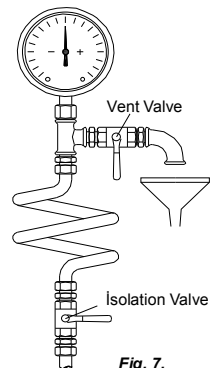
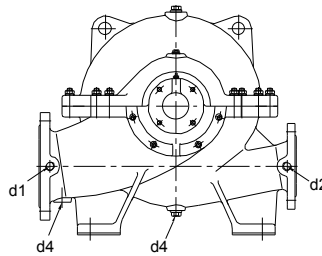
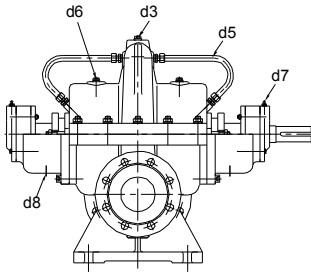

Fig. 7.



- d1: Pressure gauge (suction).
- d2: Pressure gauge (discharge).
- d3: Filling or venting.
- d4: Drain.
- d5: Stuffing box flushing pipe.
- d6: Air vent screw.
- d7: Grease nipple.
- d8: Seal leakage drain

Fig. 8

C5.5- Minimum flow

If there is a possibility of the pump having to operate at zero flow (against a closed discharge valve) or near the closed valve with almost no flow, then a minimum flow valve (or a by-pass check valve) must be installed on the discharge nozzle or on the discharge piping right after the pump but before the flow regulating valve. In cases where there is no such a valve operating the pump against close valve for a long time causes considerable damage on the pump since almost all the motor power is transformed into thermal energy which is absorbed by the pumped liquid.

C5.6- Electrical connections



- The electrical motors have to be built in accordance with EN 60034-1.
- Enclosures of electrical motors and control systems on the pump unit shall as a minimum give protection in accordance with EN 60529 IP22. But in determining the degree of protection of enclosures of electrical motors and control systems on the pump unit the operating and environmental conditions must be taken into consideration.
- Electrical connection should be done by a qualified electrician. Current national regulation and motor manufacturer's instructions must be observed.
- Take all safety precautions listed in "Safety instructions". Disconnect all power supplies prior to doing any work.
- The supply cable must be laid in such a way that it never touches the pipework, pump and motor casing.
- Check voltage, phase and frequency on motor nameplate with the mains.
- The electric motor must be protected against overloading by means of circuit breakers and/or fuses. Circuit breakers and fuses must be selected in accordance with full load amperage of the motor appearing on the motor rating plate.
- It is recommended to use PTC (passive thermal control) on motor, but this is optional depending on customer requirement. In case of using PTC, these should be connected via corresponding terminals in the terminal box and the PTC should be connected to the thermal trip mechanism.
- Prior to connecting the electrical wiring rotate the pump shaft by hand to make sure rotor rotates easily.
- Connect the electrical wiring in accordance with local electrical codes and make sure to ground the motor.
- The connection diagram can be found in the terminal box of the motor or in the instruction manual.
- The mains connection on the tagboard depends on the nominal power of the motor, the power supply and the type of connection. The necessary connection of the bridges in the terminal box is shown in the following (Table 1. and Fig. 9a, 9b, 9c).

Table 1

| Type of switch | Motor Power $P_N \leq 4 \text{ kW}$ | Motor Power $P_N > 4 \text{ kW}$ |
|----------------------|--|-------------------------------------|
| | | power supply 3 ~ 400 V |
| direct | Y – connection (9b) | Δ – connection(9a) |
| Y / Δ - start | Impossible | Remove connecting bridges (9c) |

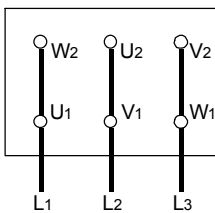

Fig. 9a. Δ - connection

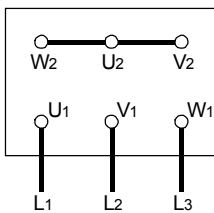

Fig. 9b. Y - connection

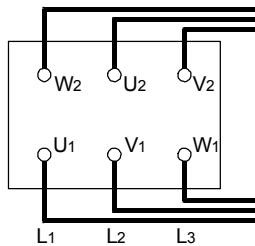

Fig. 9c. Y / Δ - start

ATTENTION In the case of three-phase induction motors with Y – Δ – connection it must be ensured that the change-over points between star and delta follow on from one another very quickly. **Longer change-over times may result in pump damage (Table 2).**

Table 2

| Motor Power | Y - set time |
|-------------|--------------|
| ≤ 30 kW | < 3 sec |
| > 30 kW | > 5 sec |

C5.7- Final check

- After completion all the above process check the coupling alignment once more as described in C4. Correct if there is a fault. Rotate the pump rotor several times by hand. Make sure rotor rotates easily. Fix the safety guards in places then run the unit until it warms up and normal operating conditions are reached. Now shut it down and make final alignment by shimming driver only. **Final alignment should be made at operating temperature.**



- Fix the safety guards back in places. Do not operate the pump before doing so. This is a necessity for security and job safety.

D- START UP / SHUT DOWN

D1- Preparation

D1.1- Lubrication control

- Grease lubricated bearings are factory packed with grease enough for one year operation before dispatch. Before initial start up the pump it should be ascertained that no dirt has penetrated inside the bearing during transport or installation on site. Otherwise, the bearings should be cleaned out and repacked with fresh grease before start up.
- If the pump is stored for a long time before installation (more than 6 months) pump extra grease on bearings.
- See E for lubricating.

D1.2- Check the shaft seal (see F3)

D1.3- Venting and priming

- Make sure that the pump and suction pipes are completely filled up with water. There is no problem for the pumps which have positive suction head. If there is a valve on suction line, it must be opened and air taps are loosened to enable the water replaces air in the pump, until it is completely full with water.
- If there is a foot valve for the pump, which has suction lift, pump is filled up with water through the filling tap at the highest point of the pump and the air is emptied out.
- If the system has a vacuum pump, water is brought up in the rising pipe and filled up the pump through this vacuum pump. When water is risen up to the highest point then the pump is started up.

ATTENTION Make sure the pump never runs dry.

D1.4- Checking the direction of rotation

SDS type pumps rotate in clockwise when it is looked from coupling to the pump. This direction is already indicated on the pump nameplate by an arrow. Check this by switching the pump on, then off again immediately. Fit the coupling guard back in place if you took it out.

D2- Start Up The Pump

- Check if the shut off valve in the suction line is open and the shut off valve in discharge line is closed.
- Switch on the circuit breaker and run the motor.
- Wait until the motor reaches the full speed (on star-delta running motors wait until it switches on delta).
- Open the discharge valve slowly while watching the ampermeter on the control panel (if the discharge line is empty do not turn on the valve fully open on first start up. Turn it on slowly to maintain the value on the ampermeter is under the rated current value of the motor).
- When the valve is if fully open, check the pressure on the manometer and see it is the same with the duty point pressure. If the pressure on the pressure gauge is lower than duty point pressure brings them to the duty point value by slightly closing the valve. If it is higher value, check your installation, particularly head again.

ATTENTION The pump should be shut down at once and the trouble should be corrected if the pump is running at its rated speed and found any of the following faults:

- Pump doesn't deliver any water,
- Pump doesn't deliver enough water,
- Flow is going down,
- Discharge pressure is not enough,
- Driver overloaded,
- Vibration on pump,
- High noise level,
- Bearing overheating

D3- Shut Down The Pump

- Slowly close the shut-off valve in the discharge line.
- You may shut down the pump without closing the shut-off valve if there is a device for water hammer protection on the discharge line or the water hammer is not a considerable level.
- Switch off the driver. Ensure the pump set runs down smoothly and quietly to a standstill.
- Shut off external sealing liquid supply, if supplied, to relieve stuffing box pressure.
- If the set is to remain out of services for a long time close the shut-off valve in the suction pipe. Close off the auxiliary connections. In the event of frost and/or prolonged standstill, drain the pump or otherwise protect against freezing.

D4- Checks to be Made While The Pump is Running

- The pump must run smoothly, quietly and free from vibration at all times.
- The pump must never run dry.
- Never run the pump for along period against a closed discharge valve (at zero flow).
- The bearing temperature may exceed the ambient temperature by up to 50° C. But must never rise above 80° C.
- The valves in the auxiliary lines must remain open while the pump is running.

If the pump has soft packing type stuffing boxes, these should drip during operation. The gland nuts should only be lightly tightened. In case of excessive leakage from the stuffing box tighten the gland nuts slowly and evenly until the leakage is reduced to the dripping state. Check the stuffing box for overheating by hand. If the gland nuts can not be tightened any further remove the old packing rings and clean the packing chamber and insert the new packing rings. Make sure that each packing ring is cut of correct size. The joint in successive ring should be offset to each other.

- If the pump has a mechanical seal, these will experience only minor leakage or no visible leakage during operation. It is maintenance free. If there is considerable leakage from the seal, that means the seal surfaces are worn-out and it needs to be replaced. The operation life of the mechanical seal highly depends on the purity of the water.
- The flexible coupling elements should be regularly checked and replaced as soon as they are shown signs of wear.

- Occasionally check the motor current. Stop motor if the amperage is higher than usual; there may be jamming or friction in the pump. Make the necessary mechanical and electrical checks.
- Stand-By pumps should be run for a short time at least once a week to ensure they are in constant readiness for operation. Check the integrity of auxiliary connections.

E- LUBRICATION

- Bearing of SDS type pumps are either life-time grease lubricated or grease lubricated ball bearings.
- Life-time grease lubricated bearings are maintenance free.
- See the attached *Table 3* for bearings type and size.

Table 3

| Pump Dimension Group* | Shaft end Dimension (ø) | Bearing Type |
|-----------------------|-------------------------|--------------|
| B | 42 | 6310 C3 |
| C | 55 | 6312 C3 |

(*) Grouped according to the shaft form.

Periods of re-greasing

- The grease should be changed after about 1500 to 2000 operating hours or if, owing to repeated shut-downs, the number of operating hours is not reached with in one year regrease the bearings in intervals of approximately 12 to 15 months. Using shorter intervals might result in overheating and consequently shorten bearing life.

ATTENTION

- The bearing temperature may exceed the ambient temperature by up to 50° C. But never rise above 80° C.
- Do not reuse the bearings following disassembly for maintenance purposes.

F- DISASSEMBLY, REPAIR AND REASSEMBLY



- Before starting work on the pumpset, make sure it is disconnected from the mains and can not be switched on accidentally.



- Follow the safety precaution measures outlined in “safety instructions”.

F1- Disassembly

- Close all valves in the suction and discharge lines, and drain the pump by opening the drain plug (231) and the air plug (230).
- Disconnect the stuffing boxes flushing pipes (500).
- Remove coupling guard and other safety guards (**See section M for safety guard**).
- Remove all casing main joint nuts and dowel pins.
- Separate the casing halves, lifting off the upper half casing (013). This reveals the pump internals (impeller, wear rings) for inspection.
- Unscrew the bolts which are connecting the bearing housings (030) to the bottom half casing (014).
- Lift the rotor out of the bottom half casing.
- Pull off the pump end coupling half from the shaft using a pull-off device and remove the coupling key (211).
- Remove bearing covers (034) and bearing end covers (035).
- Pull the bearing housing (030) off the bearings (200).
- Unscrew the shaft nuts and lock washers (391).
- Pull the bearings (200) off the shaft (060) and remove.
- Remove in sequence bearing covers (034), throwers (088), spacer sleeves (071), stuffing boxes (003), shaft protecting sleeves (070), wear rings (020), impeller (050) and impeller key (210).
- Clean all the parts, replace damaged or worn-out ones.

F2- Reassembly

- Reassembly proceeds in reverse sequence to dismantling as described in section F1. You may find the attached drawing useful. The following points should be noted more particularly:
- Never use old o-rings and make sure the new o-rings are the same size as the old ones.
- Before mounting the shaft protecting sleeves (070) inspect the condition of their rubbing faces. Use new sleeves if the old ones are badly worn, scored or rough.
- The joint faces of the casing halves are sealed with liquid sealing compound. The joint faces should be thoroughly cleaned before reassembly and coated over again with sealing compound. NEVER USE A PAPER GASKET BETWEEN THE TWO FACES.

F3- Shaft Seal

- While starting to change soft packing thoroughly clean the stuffing box and shaft sleeve.
- Cut enough number of pieces at the suitable length diagonally from suitable size of soft packing. Roll it up over the shaft sleeve and see the ends are in full contact.
- Insert the first packing ring as the joint will place up, and press home using the gland cover.
- Place the second ring as joint will place down. Insert all the packing rings in the same way. If there is a lantern ring put into place too.
- Place the gland and fully tighten, thus the packing rings will take the shape of stuffing box, then loosen it. Slightly tighten by turning the shaft and stop tightening when it slightly brakes the shaft.
- After starting operation, it is necessary that water drips from the packing. This dripping shouldn't be less than 10 cm³/min and more than 20 cm³/min. Adjust dripping by uniformly tightening and slackering the gland nuts slightly.
- Check the temperature of soft packing after two hours operation after gland adjustment to avoid overheating. Packing temperature must not exceed 80°C where pumping liquid temperature is the same as ambient temperature.

G- SPARE PARTS

- STANDART POMPA guarantees to supply the spare parts for SDS type pumps for 10 years. You can provide any spare parts easily.
- Lets us know the following details on the name-plate, when you order spare parts.

Pump Type and Size : (SDS 125 - 315)
Motor Power and Speed : (30 kW - 1450 rpm)
Prod. Year and Serial Number : (2011 - 1445010)
Capacity and Head : (200 m³/h - 30m)

- If you prefer to have spare parts in your stock, we recommed you to have the following quantities for a two years operation depending on the number of same type of pumps (**Table 5**).

Table 5

| Part No | Part Name | Number of pumps in the system | | | | | | |
|---------|---------------------------|-------------------------------|---|----|----|-----|-----|------|
| | | 2 | 3 | 4 | 5 | 6-7 | 8-9 | 10+ |
| 60 | Shaft (Incl. keys) | 1 | 1 | 2 | 2 | 2 | 3 | 30% |
| 50 | Impeller | 1 | 1 | 1 | 2 | 2 | 3 | 30% |
| 20 | Wear Ring | 4 | 4 | 4 | 6 | 6 | 8 | 50% |
| 200 | Ball Bearings | 2 | 2 | 4 | 4 | 6 | 8 | 50% |
| 70 | Shaft sleeve | 4 | 4 | 4 | 6 | 6 | 8 | 50% |
| 400 | Soft packing (set) | 8 | 8 | 12 | 12 | 12 | 16 | 40% |
| 405 | Mechanical Seal (if used) | 4 | 6 | 8 | 8 | 8 | 12 | 90% |
| 420 | O-Rings for casing | 4 | 6 | 8 | 8 | 9 | 12 | 150% |

H- FAULTS, CAUSES and REMEDIES

In this section you will find operating faults which may arise, and their causes (**Table 6**), and suggested remedies (**Table 7**).

ATTENTION Before remedying operating faults, check all measuring instruments used for reliability and accuracy.

Table 6

| FAULTS | POSSIBLE CAUSES |
|---|---------------------|
| Pump doesn't deliver any water after start-up | 1-5-7-10-11-13 |
| Flow is going down or no flow at all | 2-3-8-14 |
| Driver overloaded | 9-12-17-18-19-27-28 |
| Bearings overheating | 19-20-21-22-24 |
| Vibration on pump | 15-16-19-23-25 |
| Noise level is high | 4-6-26 |

Table 7

| | POSSIBLE CAUSES | REMEDIES |
|----|---|---|
| 1 | There may be air existing in pump or suction pipe | Fill pump and suction pipe completely with liquid and repeat the priming procedure. |
| 2 | Ingress of air through shaft seal, suction pipe or suction port. Pump lifts liquid with air | Check for leaks in suction pipe joints and fittings. Check shaft seal if necessary increase the pressure of sealing liquid. Check the dept of suction pipe or foot valve in the liquid and if necessary increase the depth of them. |
| 3 | Air pocket in the suction pipe. | Check the slope of the suction line make sure that there is no reason for formation of air pockets |
| 4 | There is air in liquid | Suction pipe is not submerged enough creating vortex. Check liquid level in suction tank or increase the depth of suction pipe or foot valve in the liquid. |
| 5 | Too much suction lift | If no obstruction at inlet check the friction losses of suction line, larger piping may correct condition. If static lift is too high, the liquid level in the suction tank must be raised or the pump lowered. |
| 6 | Pump is working at cavitation conditions | NPSH available is too low. Check liquid level in suction tank, check suction line for excessive friction losses. Check isolating valve in suction line to make sure it is completely open. If necessary increase suction head on pump by lowering the pump. |
| 7 | Insufficient manometric head. | The actual total head is higher than that originally specified. Check the geodetic total head and friction losses in the discharge line. Larger piping may correct the condition. Check that valves are fully open. |
| 8 | Increase at total manometric head. | Check that valves are fully open. Check that there is any obstruction in discharge pipe. |
| 9 | Pump is operating at lower manometric head. | The actual total head is lower than that originally specified. Machine impeller outer diameter to size advised by supplier. |
| 10 | Reverse rotation. | Check motor rotation with directional arrow on pump casing or nameplate. |
| 11 | Speed is too low. | Check the supply voltage and frequency or motor may have open phase. |
| 12 | Speed is too high. | If possible decrease the pump rotational speed or turn down the impeller outer diameter to size advised by supplier. |
| 13 | Impeller or check valve or strainer is clogged. | Clean the impeller or check valve or strainer |
| 14 | Impeller or strainer is clogged partially. | Clean the impeller or strainer. |
| 15 | Partially clogged impeller. | Clean the impeller. |
| 16 | Worn out and defected impeller. | Replace impeller. |
| 17 | Mechanical frictions inside the pump. | Check pump rotor for any rotor obstruction or deflection. |
| 18 | Excess tightened soft packing. | Loosen the nuts of the packing gland. |
| 19 | Bad coupling alignment. | Check the coupling rubber and realign the coupling. |
| 20 | Bearing covers are too tight. | Check and make necessary modification on the cover. |
| 21 | The pumped flow is less than the minimum flow required. | Increase the flow. If necessary use by-pass recirculating valve or line. |
| 22 | Existence of excess grease. | Remove excess grease. |
| 23 | Oblique shaft. | Check the shaft and replace it if necessary. |
| 24 | Insufficient lubrication or lubricating oil/grease dirty, contaminated. | Check the amount of oil/grease. Clean the bearings and bearing housing and relubricate |
| 25 | Unbalanced rotating parts. | Check the balance of the rotating parts. |
| 26 | Pump runs out of duty range. | Check the values of operating point. |
| 27 | The density or viscosity of the liquid pumped is higher than that originally specified. | Use a more powerful motor. |
| 28 | Defects in motor. | Check any motor defects. The motor may not be ventilated properly due to a poor location. |

I- TIGHTENING TORQUES

| Tightening Torques | | |
|--------------------|-----------------------------|------|
| Thread Diameter | Tightening Torque max (N.m) | |
| | Property Classes | |
| | 8.8 | 10.9 |
| M4 | 3.0 | 4.4 |
| M5 | 5.9 | 8.7 |
| M6 | 10 | 15 |
| M8 | 25 | 36 |
| M10 | 49 | 72 |
| M12 | 85 | 125 |
| M14 | 135 | 200 |
| M16 | 210 | 310 |
| M18 | 300 | 430 |
| M20 | 425 | 610 |
| M22 | 580 | 820 |
| M24 | 730 | 1050 |
| M27 | 1100 | 1550 |
| M30 | 1450 | 2100 |
| M33 | 1970 | 2770 |
| M36 | 2530 | 3560 |

J- EXPECTED NOISE VALUES

| Power of Motor P_N (kW) | Sound pressure level (dB _A) * (Pump with motor) | |
|---------------------------------|--|----------|
| | 1450 rpm | 2900 rpm |
| < 0.55 | 60 | 64 |
| 0.75 | 60 | 66 |
| 1.1 | 62 | 66 |
| 1.5 | 63 | 68 |
| 2.2 | 64 | 69 |
| 3 | 65 | 70 |
| 4 | 66 | 71 |
| 5.5 | 67 | 73 |
| 7.5 | 69 | 74 |
| 11 | 70 | 76 |
| 15 | 72 | 77 |
| 18.5 | 73 | 78 |
| 22 | 74 | 79 |
| 30 | 75 | 81 |
| 37 | 75 | 82 |
| 45 | 76 | 82 |
| 55 | 77 | 84 |
| 75 | 78 | 85 |
| 90 | 79 | 85 |
| 110 | 80 | 86 |
| 132 | 80 | 86 |
| 160 | 80 | 86 |

(*) Without protective sound hood, measured at a distance of 1 m directly above the driven pump, in a free space above a sound reflecting surface.

K- PERMISSIBLE FORCES AND MOMENTS AT THE PUMP FLANGES

| Type | Suction Flans | | | | | | | | | | Discharge Flans | | | | | | | |
|---------|---------------|------|------|------|----------------|-----|-----|-----|----------------|-----|-----------------|------|------|----------------|-----|-----|-----|----------------|
| | DN | Fx | Fy | Fz | F ^b | Mx | My | Mz | M ^b | DN | Fx | Fy | Fz | F ^b | Mx | My | Mz | M ^b |
| 100-250 | 150 | 2000 | 1800 | 1600 | 3100 | 750 | 530 | 620 | 1100 | 100 | 1300 | 1200 | 1100 | 2100 | 530 | 380 | 440 | 780 |
| 125-315 | 200 | 2700 | 2400 | 2200 | 4200 | 980 | 690 | 800 | 1400 | 125 | 1600 | 1400 | 1300 | 2500 | 630 | 450 | 570 | 920 |

* Forces in Newton [N], moments in Newton x Meter [N.m].

** Values are applicable for casing material "Grey Cast Iron (EN-JL-250 / GG25)".

Higher values are permissible for steel construction pumps.

The following condition must be satisfied;

$$\left(\frac{\sum |F|_{actual}}{\sum |F|_{max, allow}} \right)^2 + \left(\frac{\sum |M|_{actual}}{\sum |M|_{max, allow}} \right)^2 \leq 2$$

Where total loads $\sum |F|$ and $\sum |M|$ are the arithmetic sums for each flange (inlet and outlet) without taking account their algebraic sign.

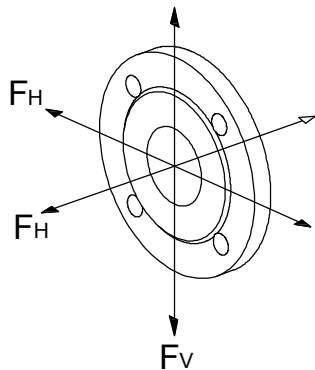

L- SECTIONAL DRAWINGS

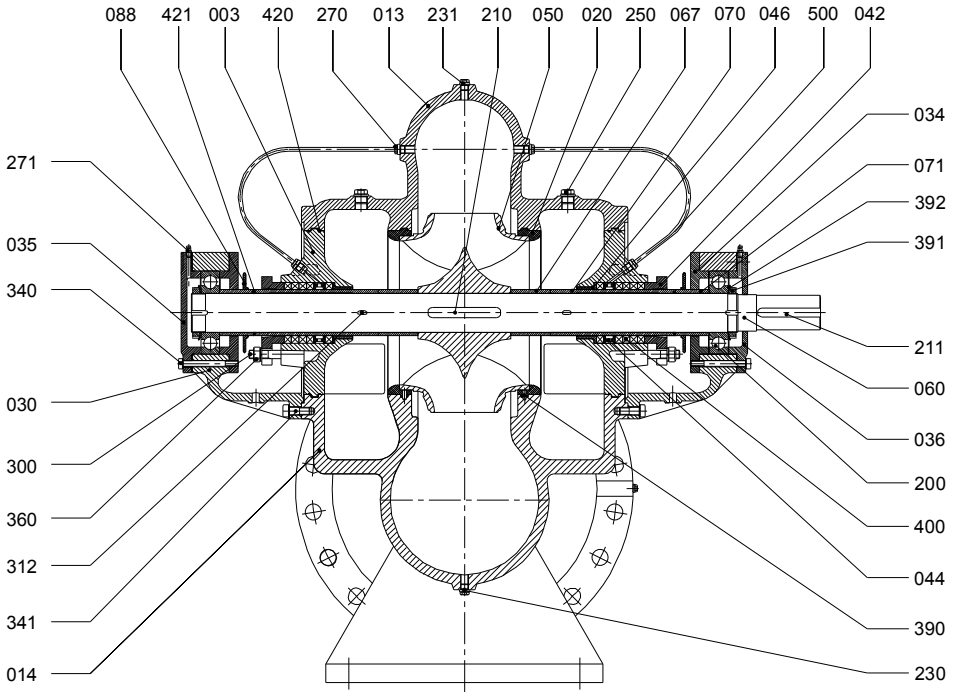

PART LIST

| | | | |
|-----|-----------------------------|-----|-----------------------|
| 003 | Stuffing Box | 211 | Coupling Key |
| 013 | Volute Casing (top half) | 212 | Spacer Key |
| 014 | Volute Casing (bottom half) | 230 | Air Plug |
| 020 | Wear Ring | 231 | Drain Plug |
| 030 | Bearing Bracket | 250 | Air Vent Screw |
| 034 | Bearing Cover (inboard) | 260 | Grease Nipple |
| 035 | Bearing Cover (outboard) | 270 | Flushing Pipe Fitting |
| 036 | Bearing Cover (coupling) | 300 | Stud |
| 042 | Stuffing Box Gland | 320 | Hex.Head Bolt |
| 044 | Lantern Ring | 321 | Hex.Head Bolt |
| 046 | Stuffing Box Ring ** | 360 | Hex. Nut |
| 048 | Mechanical Seal Cover | 390 | Pin |
| 050 | Impeller | 391 | Shaft Nut |
| 060 | Pump Shaft | 392 | Lock Washer |
| 067 | Impeller Dayama Burcu | 400 | Soft Packing |
| 070 | Shaft Protecting Sleeve | 420 | O-Ring |
| 071 | Spacer Sleeve | 421 | O-Ring |
| 088 | Thrower | 422 | O-Ring |
| 200 | Ball Bearing | 500 | Flushing Pipe |
| 210 | | | |

* Optional

M- COUPLING GUARD AND SAFETY GUARD

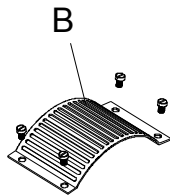
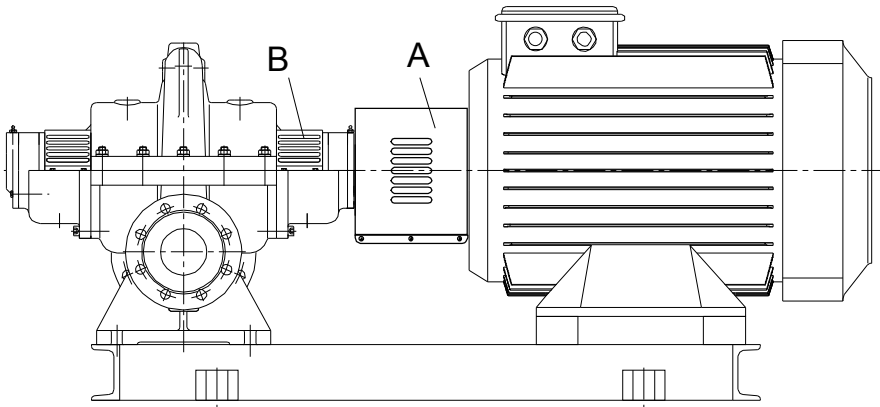

Safety guard

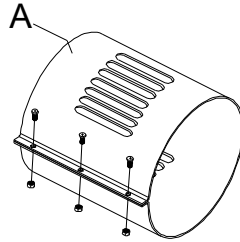

Coupling guard

Note: All guards are conforming to EN 294.

EC DECLARATION OF CONFORMITY

Products: Pumps of type SDS with motor and baseplate

Manufacturer:

Standart Pompa ve Makina San. Tic. A.Ş.

Organize San. Bölgesi 2. Cad. No:9

34775 Esenkent / Ümraniye / İSTANBUL / TURKEY

t: +90 216 466 89 00 f: +90 216 499 05 59

www.standartpompa.com / info@standartpompa.com

The manufacturer herewith declares that the described products meet the essential requirements of **Machinery Directive 2006/42/EC and Low Voltage Directive 2006/95/EC.**

Harmonised standards applied are;

- EN 809
- EN ISO 12100:2010
- EN 60204-1



Şeref T. ÇELEBİ
General Vice Manager
İstanbul, 12th January 2011

The product is marked with **CE** on its name plate.

MANUFACTURER DECLARATION OF CONFORMITY

Products: Pumps of type SDS (bareshaft)

Manufacturer:

Standart Pompa ve Makina San. Tic. A.Ş.

Organize San. Bölgesi 2. Cad. No:9

34775 Esenkent / Ümraniye / İSTANBUL / TURKEY

t: +90 216 466 89 00 f: +90 216 499 05 59

www.standartpompa.com / info@standartpompa.com

The manufacturer herewith declares that the described products meet the essential requirements of **Machinery Directive 2006/42/EC.**

Before the pump is put into operation, the machinery unit in which the pump is functioning to be declared in conformity to relevant regulations.

Harmonised standards applied are;

- EN 809
- EN ISO 12100:2010



Şeref T. ÇELEBİ
General Vice Manager
İstanbul, 12th January 2011



Standart
POMPA ve MAKİNA SANATİ TİC. AŞ.

www.standartpompa.com / e-mail: info@standartpompa.com.tr

Fabrika - Merkez

Yukarı Dudullu Organize San. Böl.
2.Cad. No:9 34775
İstanbul - TÜRKİYE
Pbx: +90 216 466 89 00
Fax: +90 216 415 88 60

Servis ve Yedek Parça

Yukarı Dudullu Organize San. Böl.
2.Cad. No:9 34775
İstanbul - TÜRKİYE
Pbx: +90 216 466 89 00
Fax: +90 216 466 89 13